

REV	ECN #	DESCRIPTION	DRAWING	APPROVED	DATE
A		NEW RELEASE	JIANG		

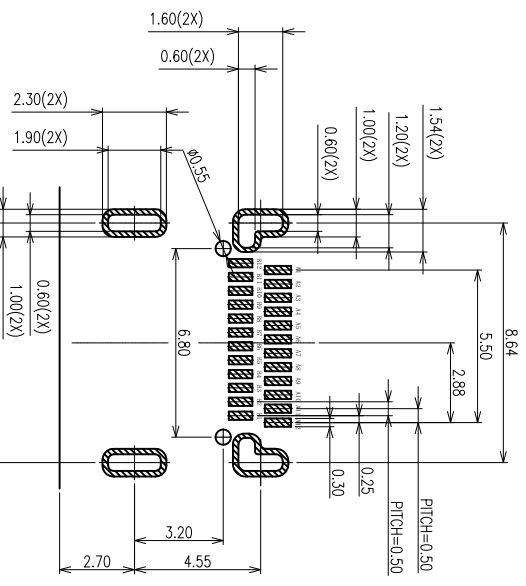
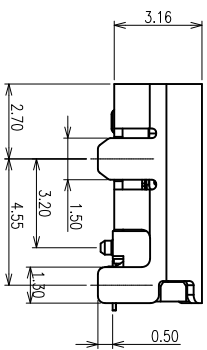
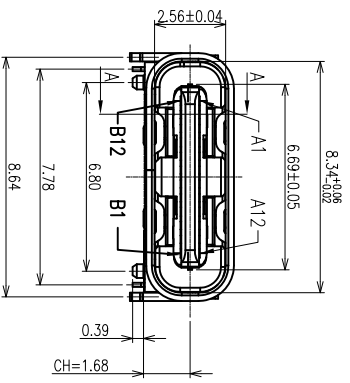
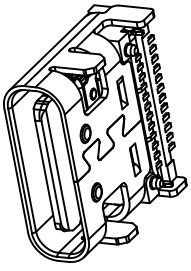
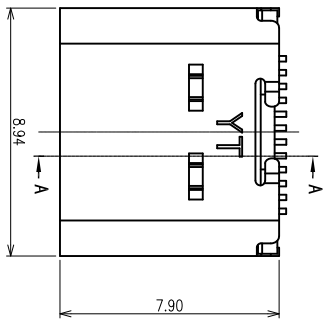

- NOTES:
SPECIFICATION:
- CURRENT RATING: 3A MAX
 - VOLTAGE: 100 VAC
 - TEMPERATURE RANGE: -30 °C ~ 85 °C
 - CONTACT RESISTANCE: 40 MILLIONHM MAX
 - INSULATION RESISTANCE: 100 MEGOHMS MIN.
 - INSERTION FORCE : 5N~20N
 - UNMATING FORCE: 8N~20N
 - DURABILITY: 10,000 CYCLES

PRODUCT NO.

UC02 - 24 C B 05 - 01

- ① 产品系列:
- UC02 : USB TYPE C REC L=7.90
- ② 产品PIN数:
- 24 : 24PIN
- ③ 材质:
- C : LCP
- ④ 颜色码:
- B : BLACK
- ⑤ 端子电镀码:
- 05 : 半金零锡"U"
- ⑥ 产品流水码:
- 01 : 板上型外壳插式

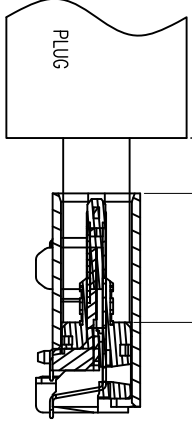

AFTER MATING

A1	GND	B12	GND
A2	SSTXP1	B11	SSRPX1
A3	SSTXN1	B10	SSRXN1
A4	VBUS	B9	VBUS
A5	CC1	B8	SBU2
A6	DP1	B7	DN2
A7	DN1	B6	DP2
A8	SBU1	B5	CC2
A9	VBUS	B4	VBUS
A10	SSRXN2	B3	SSTXN2
A11	SSRPX2	B2	SSTXP2
A12	GND	B1	GND
PIN	SIGNAL NAME	PIN	SIGNAL NAME

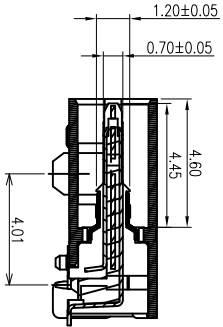
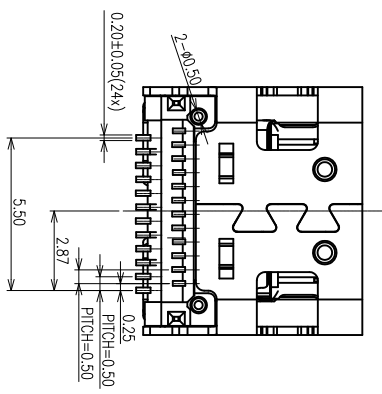

NO.	DESCRIPTION	MATERIAL	REMARKS	QTY
5	SHELL	STAINLESS STEEL		1PCS
4	SPRING	STAINLESS STEEL		1PCS
3	SHIELDING PLATE	STAINLESS STEEL		1PCS
2	CONTACT	COPPER ALLOY	Au1u 3µm/Ni:50µ Plated	1SET
1	HOUSING	HIGH TEMPERATURE PLASTIC	BLACK	1PCS

YTCOMM
Dongguan YTCOMM Electronics Technology Co., Ltd

TITLE: USB TYPE C REC 24PIN
板上型(外壳全插式)

DRAWING: JIANG
DATE: 2019. 08. 03
P/N: UC02-24CB05-01
DRAWING NO: C-UC02-01

UNIT	mm	SCALE	1:1	SIZE	A4	SHEET	1of1	REV	A
------	----	-------	-----	------	----	-------	------	-----	---

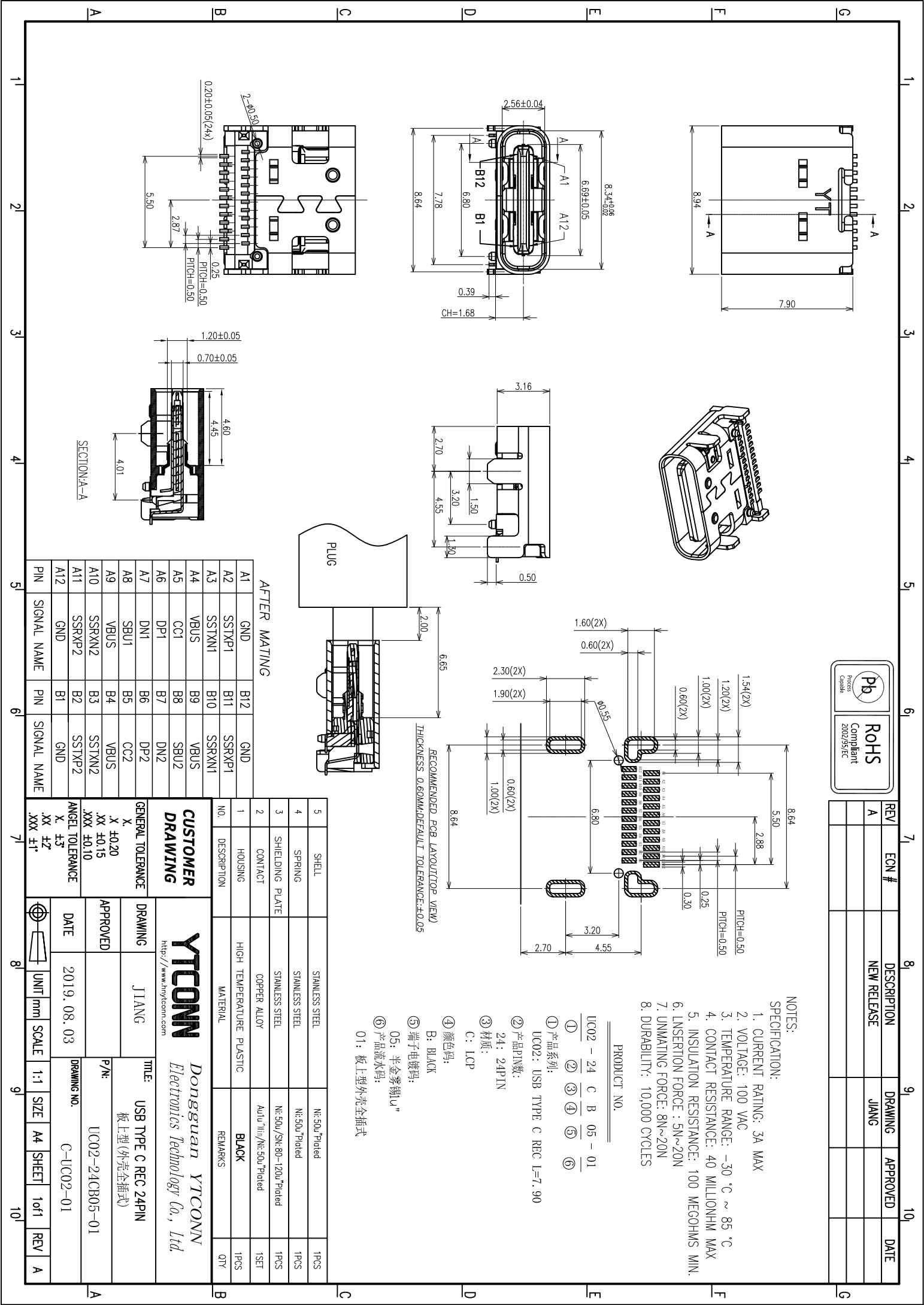

- Packing Notes:
1. Reel : 900pcs / Reel.
 2. Carton : 9900pcs / 11 Reel / Carton.

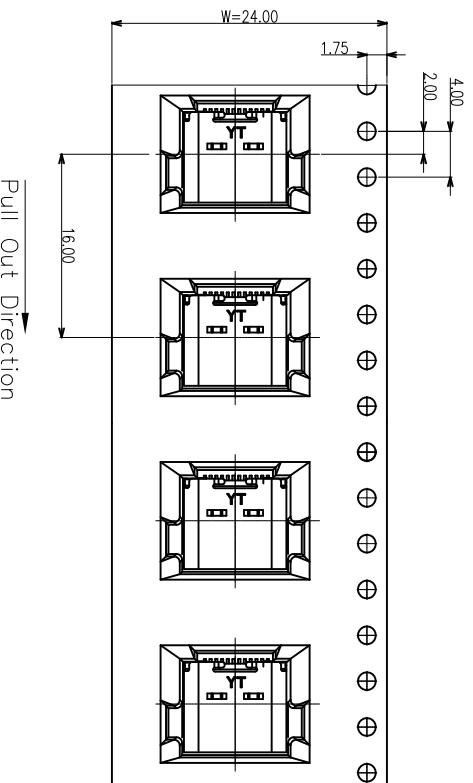
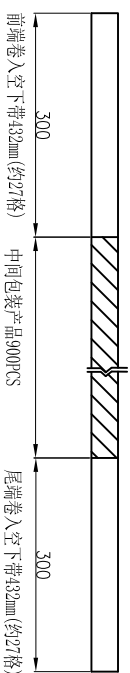
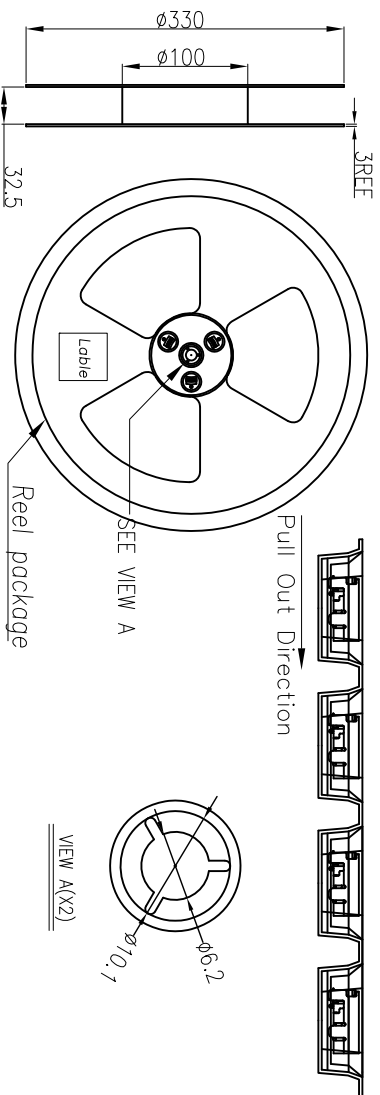

REV	ECN #	DESCRIPTION	DRAWING	APPROVED	DATE
A		NEW RELEASE	JIANG		2019.08.05

- 1) 用TAP将纸箱封实;
- 2) 将标签贴于纸箱侧 麦上方.

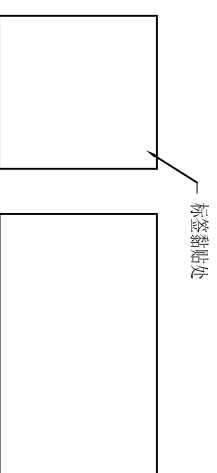

备注

(REMARK)

- 1). 若有未装满之零数箱, 必须以缓冲材料塞满.
- 2). 在搬运过程中要轻拿轻放.
- 3). 在运输中不可堆放过多, 不可有重压现象.
- 4). 上带在黏贴下带时必须平整, 且黏贴处不要出现气泡.

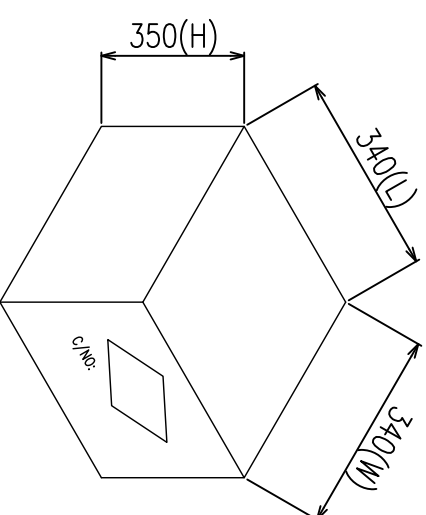

CUSTOMER DRAWING		YTCOON		Dongguan YTCOON Electronics Technology Co., Ltd.	
GENERAL TOLERANCE	X. ±0.20 XX ±0.15 XXX ±0.10	DRAWING	JIANG	TITLE:	USB TYPE C REC 24PIN
ANGLE TOLERANCE	X. ±5° XX ±2° XXX ±1°	APPROVED		P/N:	板上型(外壳全插式) 包装图
		DATE	2019.08.05	DRAWING NO.	UC02-24CB05-01
		UNIT	mm	SCALE	1:1
		SIZE	A4	SHEET	1of1
		REV		REV	A